



AP-5122m
Preliminary

AcousticPerformance™ Series

AP-5122m

High power, multipurpose
loudspeaker

Features

- DMT™ (Directivity Matched Transition) ensures smooth, coherent power response across the listening plane
- 90 degree coverage of the axisymmetric waveguide matches natural coverage of the 12-inch woofer at the crossover point for consistent power response
- 3-inch voice coil compression driver for outstanding high-frequency performance
- 40° monitor deployment angle ideal for floor monitor use
- M10 fittings, pole cup and yoke mount fittings offer flexible deployment options for a variety of applications
- Dual NL4 Speakon™ connector
- Bi-Amp / Passive switchable
- 15-ply Baltic birch plywood construction
- 16-Gauge powder coated steel grilles
- Enclosure and terminal input cup designed facilitate the cable runs for clean stage dressings
- Clean industrial design with unadorned grilles compliment most decors and settings
- Available in black (RAL 9011)
- Complete EASE, CAD & BIM information available at qsc.com



Stage Monitors · Performance Spaces · Worship Facilities · Dance/Night Clubs · Themed Entertainment

The QSC AcousticPerformance™ AP-5122m is a professional, two-way, full-range loudspeaker ideal for a variety of portable and installed sound reinforcement applications. The AP-5122m uses a high power-capacity, 76mm (3-inch) diaphragm compression driver and combines it with a 305mm (12-inch) woofer to deliver exceptional full bandwidth reproduction.

The uniform power-response of the AP-5122m loudspeaker is a result of DMT™ (Directivity Matched Transition), a design approach that matches LF and HF coverage in the cross-over region. Another key to the extraordinary accuracy and flat power response of the AP-5122m is the axisymmetric waveguide with uncompromised performance in both the vertical and horizontal axes. The result is remarkably consistent coverage and smooth, accurate reproduction on and off-axis.

The AP-5122m may be used as a passive (full-range) loudspeaker to minimize amplifier channel count or it may be bi-amplified for greater control and performance. To further enhance performance, bi-amp and full-range tunings using QSC Intrinsic Correction techniques are available for Q-Sys and future QSC products.

The AP-5122m enclosure features a 40° angle making it ideal for floor monitor use and a pole cup for deployment on a loudspeaker stand. The enclosure and terminal input cup on the AP-5122m have been designed facilitate the cable runs for a clean appearance on stage. The unit also incorporates M10 mounting points for suspension via eye-bolts as well as mount points for an optional yoke bracket.

Presenting a clean, unobtrusive look, AcousticPerformance grilles are unadorned eliminating the need to cover-up logo treatments which can be difficult to hide or remove. The grille is also lined with acoustically transparent backing adding to the enclosure's professional appearance and the unit is available in black (RAL 9011).

To minimize impact and disposal fees at the job site, all AcousticPerformance loudspeakers are packaged in environmentally friendly, recyclable cartons.

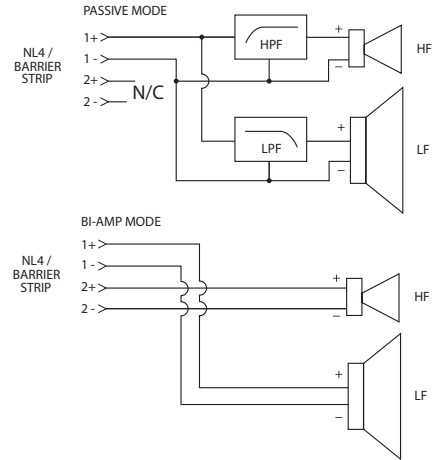
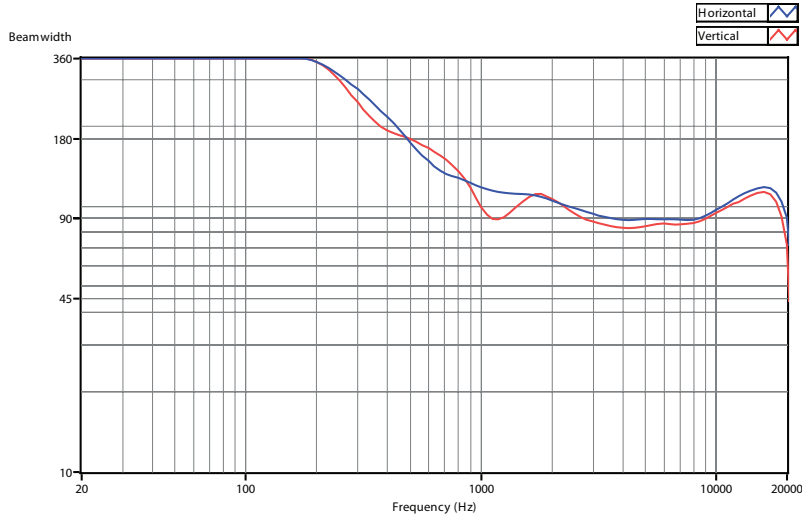

Specifications:

| System Details | |
|------------------------------------|---|
| Frequency Response (-10dB) | 55Hz – 18kHz |
| Power Capacity ¹ | 550W / 60V continuous |
| System Sensitivity ² | 95dB, 1W@1m |
| Coverage Angle | 90° Axisymmetric |
| Directivity Factor (Q) | 6.0 |
| Directivity Index (DI) | 7.8 |
| Recommended Crossover | 950 Hz, 48dB/octave |
| Maximum Rated SPL | Passive: 122dB @1m, continuous ³ 128dB @1m, peak ⁴ |
| Rated Impedance | 8Ω |
| HF Transducer | 76mm (3-inch) voice coil, compression driver; 72W / 24V (2 Hrs) |
| LF Transducer | 305mm (12-inch) driver with 102mm (4-inch) VC; 550W / 60V (2 Hrs) |
| Optional Accessories | AP-YM12m Yoke mount M10 Kit-W |
| Enclosure Details | |
| Input Connector | Dual NL4 connector |
| Enclosure Material | 15-ply Baltic birch plywood |
| Attachment Points | 11x M10 threaded inserts |
| Color | Black (RAL 9011) |
| Grille | 16 Gauge powder coated steel |
| Dimensions (HxWxD) | 660mm x 381mm x 286mm (26x15x11.3-inches) |
| Net Weight | 28.3kg (63 lb) |
| Shipping Carton Dimensions (HxWxD) | 737mm x 551mm x 447mm (29x21.7x17.6-inches) |
| Shipping Weight | 30.8kg (68 lb) |

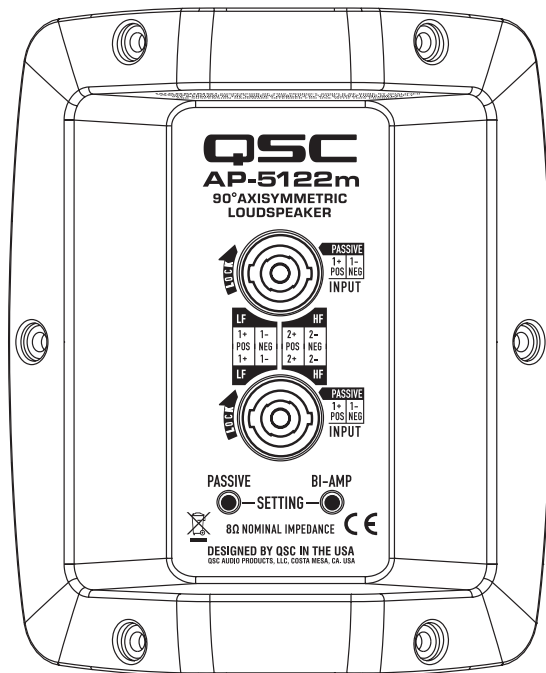

As part of QSC's ongoing commitment to product development, specifications are subject to change without notice.

¹ 2 hour rating using IEC60268 noise based on minimum impedance

² Mid-band based on nominal impedance

³ Calculated as the nominal sensitivity plus 10x the log of continuous rated power in volts squared divided by nominal impedance

⁴ Calculated as the continuous calculated max output plus 6dB

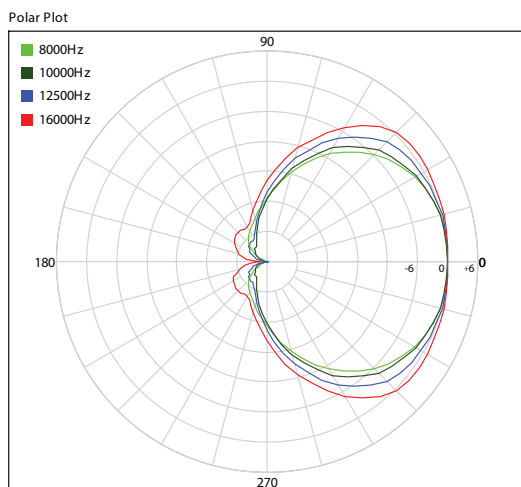
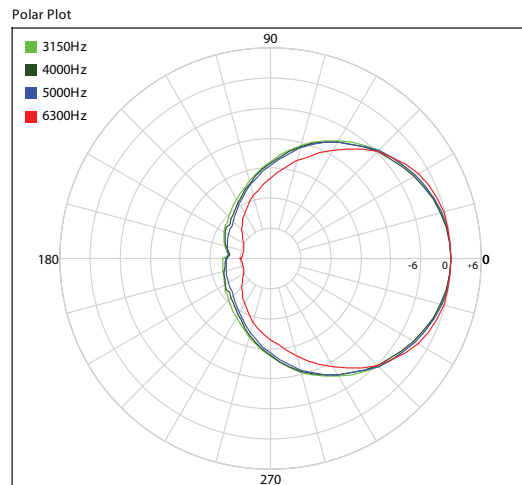
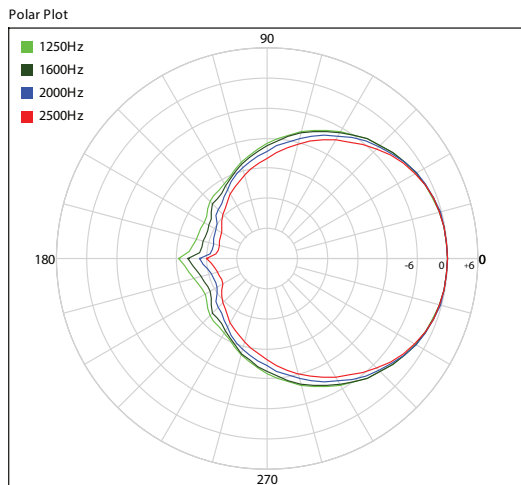
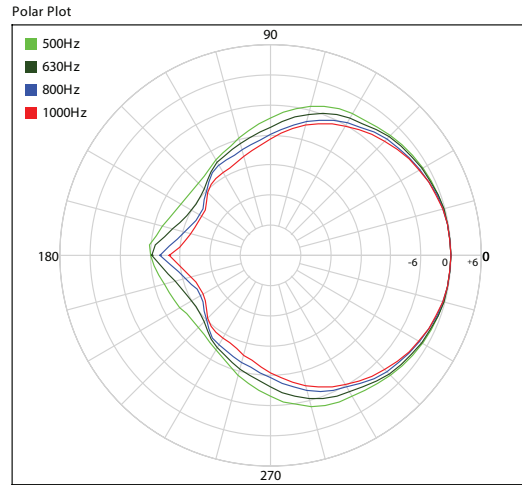
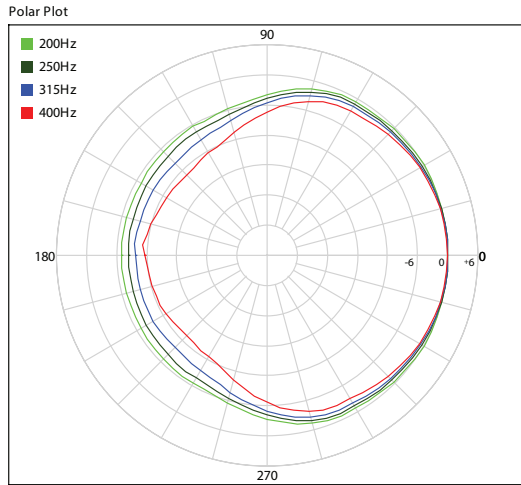

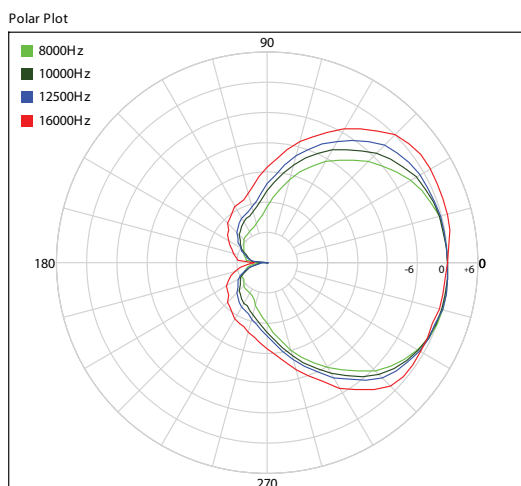
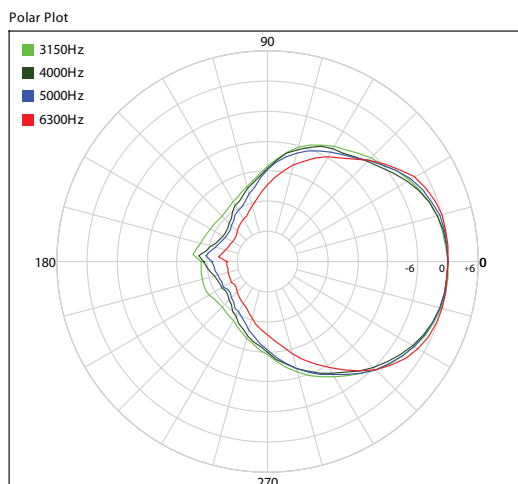
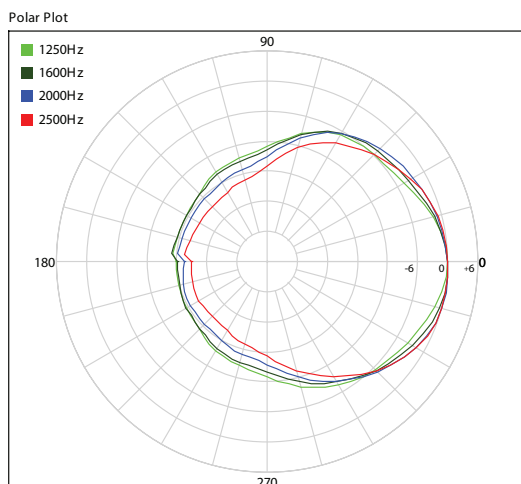
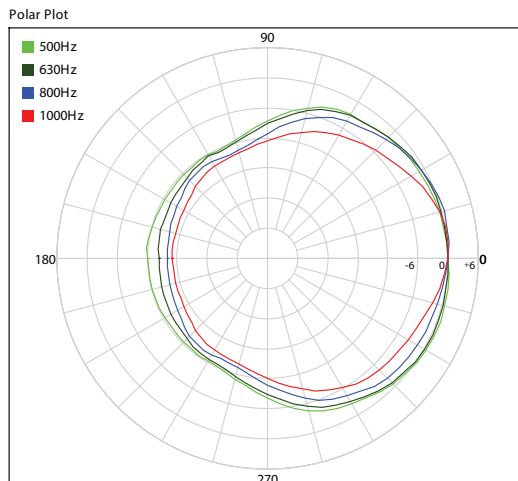
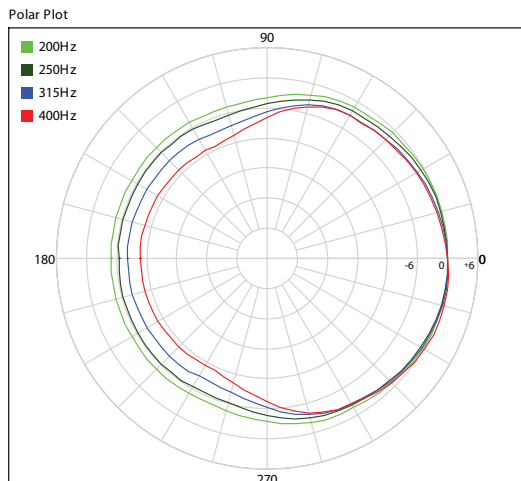

1675 MacArthur Boulevard • Costa Mesa, CA 92626 • Ph: 800/854-4079 or 714/957-7100 • Fax: 714/754-6174



please recycle

© 2012 QSC Audio Products, LLC. All rights reserved. QSC and the QSC logo are registered trademarks of QSC Audio Products, LLC in the U.S. Patent and Trademark office and other countries. DMT is a trademark of QSC. Speakon is a registered trademark of Neutrik